

SG 8500

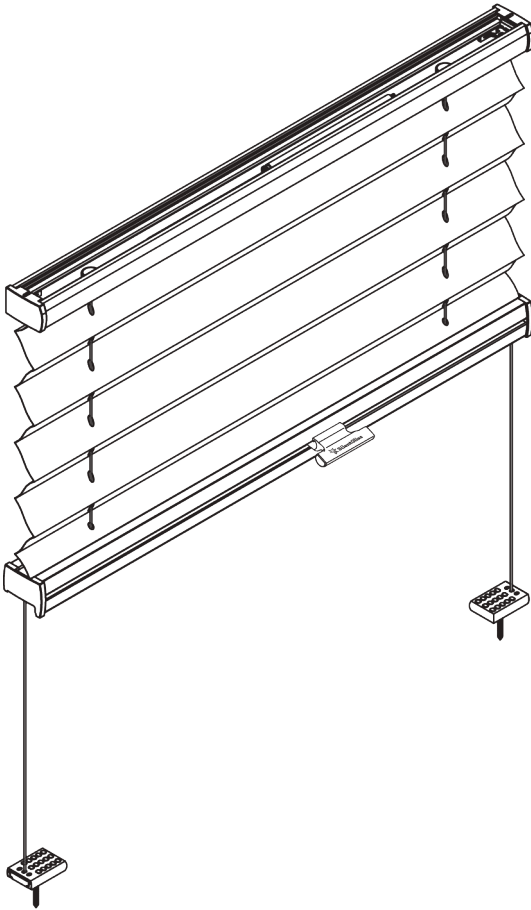
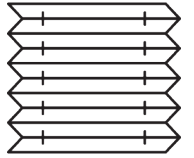

PRODUCT INFORMATION

- **Operation:** handle, chain, cord, crank, motorised
- **Range:** S - M
- **Fitting:** ceiling, wall, recess
- **Colours:** white, grey, anthracite, brushed aluminum, special colours possible
- **Fabrics:** refer to Silent Gliss pleated blind collection

Features:

- Versatile application options (including skylights, winter gardens)
- Different shapes
- Small stacking dimensions for limited space

OVERVIEW

Model name
explanation

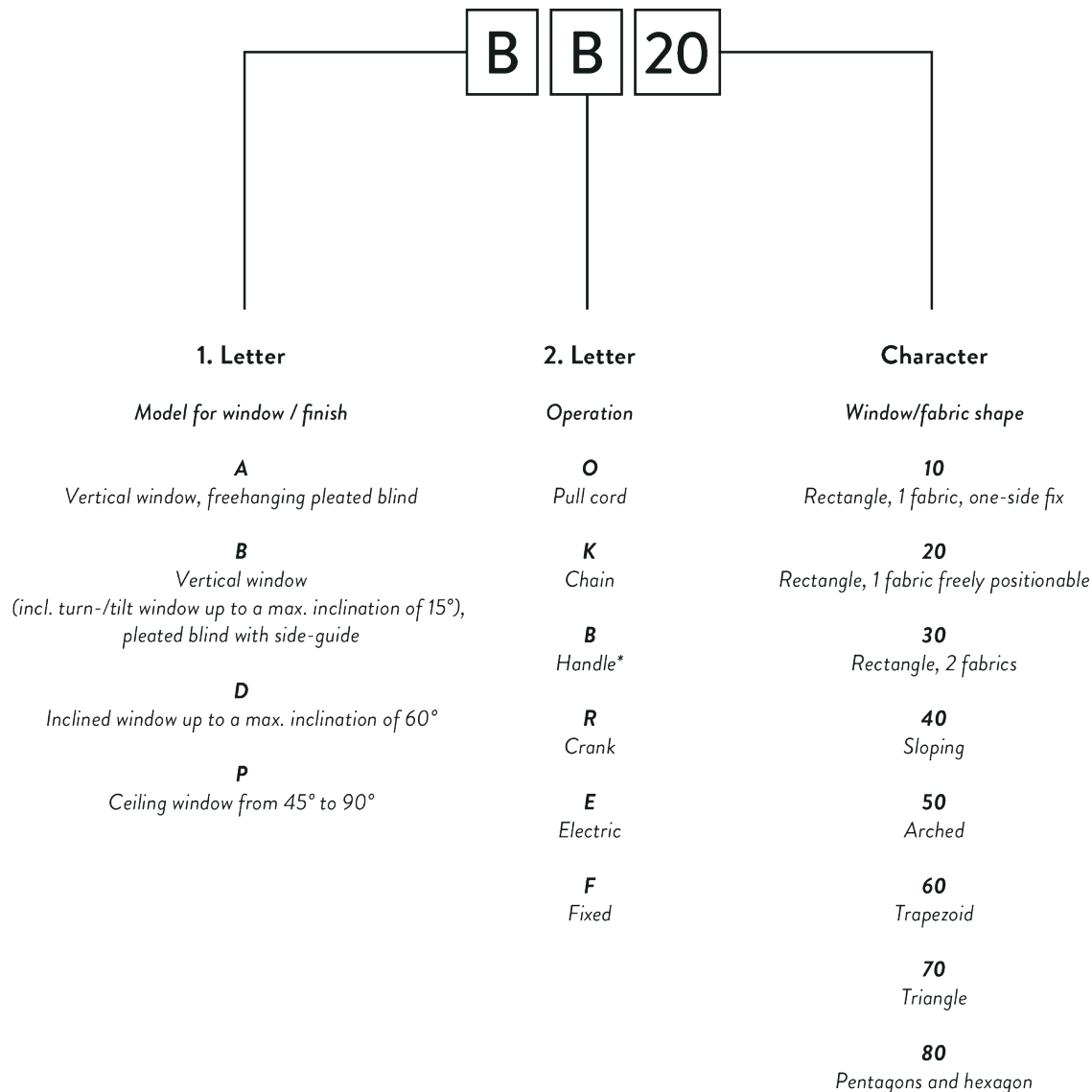

* Standard: metal operating handle
Optional: plastic operating handle,
(required when optional control
wand selected)

A. BLIND TYPES

Vertical windows

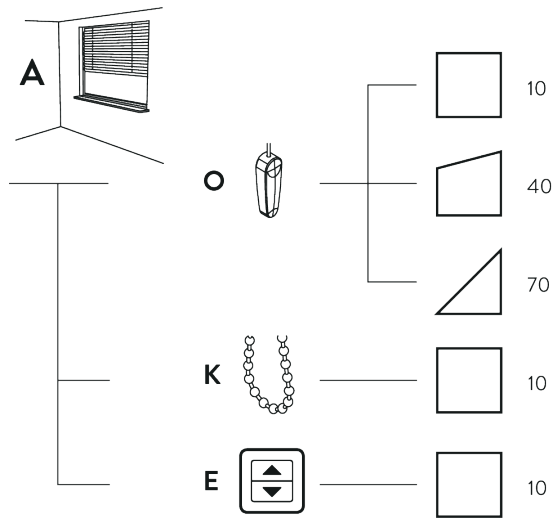

Blind type A

- For vertical windows
- Rectangular areas as well as special shapes
- Freehanging pleated blinds (without side guides)
- Various operation options

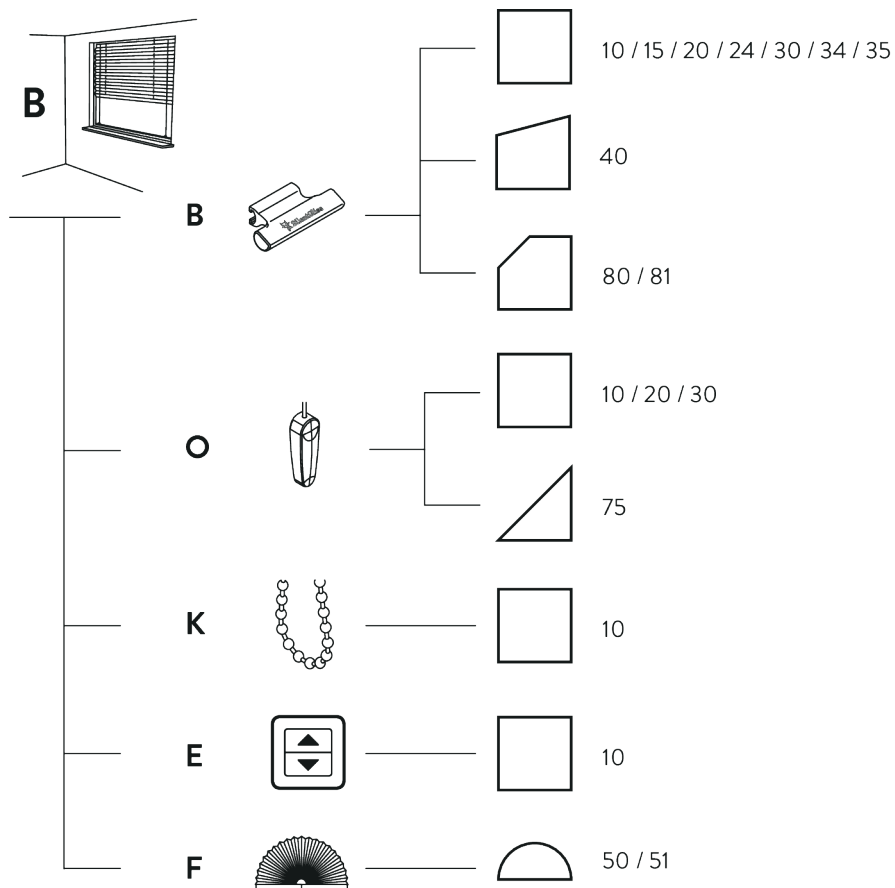

Blind type B

- For vertical windows (up to max. inclination of 15°)
- Rectangular areas as well as special shapes
- Pleated blinds with side guides
- Various operation options

Roof and pivot windows

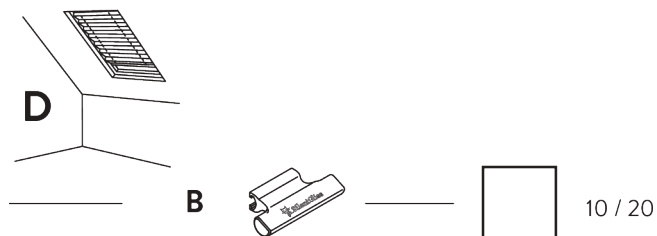

Blind type D

- Roof and pivot windows up to a max. inclination of 60°
- Only rectangular areas
- Pleated blinds with side guides
- Operation by handle

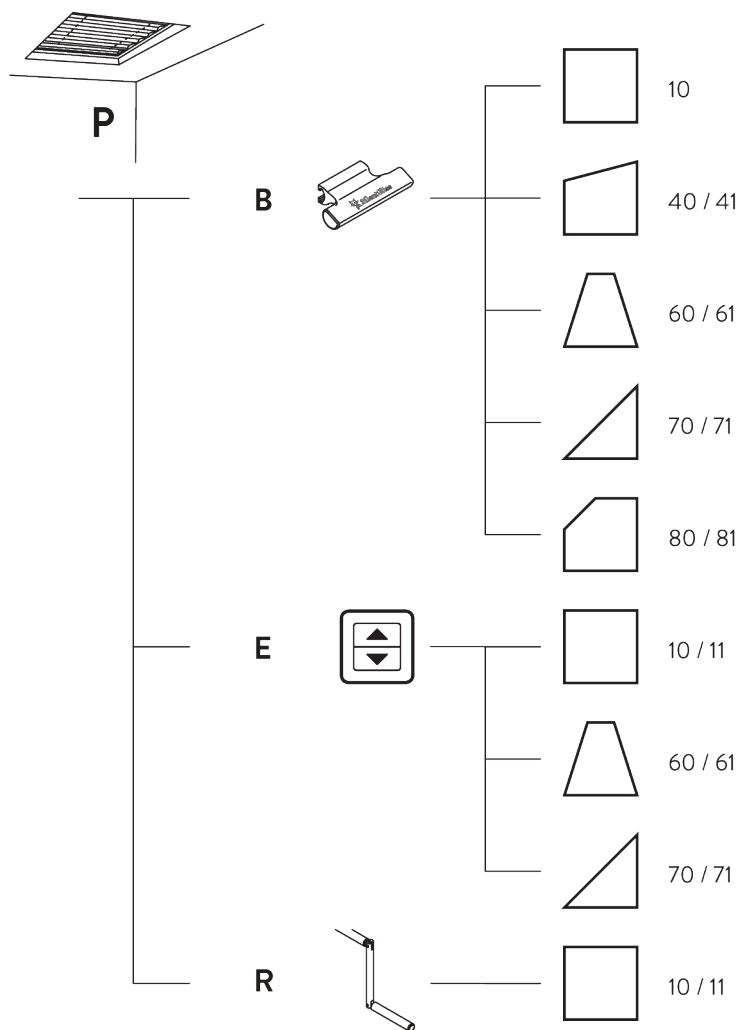

Blind type P

- For ceiling windows, skylights, wintergardens, etc.
- For an inclination between 45° and 90° (=horizontal)
- Rectangular areas as well as special shapes
- Pleated blinds with permanent steel wire tensioning
- Various operation options

DIMENSIONS / FITTING

A. FITTING INFORMATION

For detailed fitting information, visit the Silent Gliss website.

Dimensions Pleated Blind Types

Pleated Blind Type	Min. width (cm)	Max. width (cm)	Min. top width (cm)	Min. bottom width (cm)	Difference max. (cm)	Min. height (cm)	Max. height (cm)	Surface max. (m ²)	Min. angle	Max. angle
AE10	51 / 41 ^{C)}	220				10	250			
AK10	50	220				50	250			
AO10	40	220				10	250			
AO40		210		40		10	250	5 ^{B)}		50°
AO70		210		40		10	180			60° ^{D)}
BB10	15	150 ^{A)}				10	220			
BB15	15	150 ^{A)}				10	220			
BB20	15	150 ^{A)}				10	220			
BB24	25	150 ^{A)}				10	220	3		
BB30	25	150 ^{A)}				30	220	3		
BB34	25	128 ^{A)}				30	220	2.5		
BB35	25	150 ^{A)}				30	220	3		
BB40		128		30		30	220	2.5		50°
BB80		150	12	40	138	30	220			
BB81		150	12	50	138	30	220			
BE10	51 / 41 ^{C)}	220				10	250			
BF50	15	60				15	60			
BF51	30	120				15	60			
BK10	50	220				50	250			
BO10	40	220				10	250			
BO20	40	220				10	250			
BO30	40	220				10	250	5 ^{B)}		
BO75		210	40			10	180		10°	60°
DB10	30	150 ^{A)}				10	220	2.2		
DB20	30	150 ^{A)}				10	220	2.2		
PB10	20	150				10	450 ^{B)}	^{B)}		
PB40		100	0	20	100	10	250			
PB41		150	0	20	75	10	250			
PB60		150	12	20	88	10	250		10°	89°
PB61		150	12	20	69	10	250		10°	89°
PB70		100	0	20	100	10	250		10°	89°
PB71		150	0	20	75	10	250		10°	89°
PB80		100	12	40	88	30	250			
PB81		150	12	40	69	30	250			
PE10	26	220				10	450 ^{B)}	6 ^{B)}		
PE11	26	220				10	450 ^{B)}	6 ^{B)}		
PE60		220	12	26	88	10	250	5	10°	89°
PE61		220	12	26	69	10	250	5	10°	89°
PE70		100	0	26	100	10	250		10°	89°
PE71		150	0	26	75	10	250		10°	89°
PR10	20	220				10	450 ^{B)}	7 ^{B)}		
PR11	20	220				10	450 ^{B)}	7 ^{B)}		

A: From a system width of 120 cm and wider, the bottom bar may flex slightly. (No warranty claim!)

B: Please note: the max. system dimensions also depend on the fabric selection

C: Up to a height of 200 cm

D: Up to 50° with cord lock; over 50° without a cord lock

Dimensions DUETTE Blind Types

DUETTE® Blind Type	Min. width (cm)	Max. width (cm)	Min. top width (cm)	Min. bottom width (cm)	Difference max. (cm)	Min. height (cm)	Max. height (cm)	Surface max. (m ²)	Min. angle	Max. angle
AE10	51 / 41 ^{C)}	220				50	250	B)		
AK10	50	220				50	250	B)		
AO10	40	220				10	250	B)		
AO40		210		40		10	250	4 B)		50°
AO70		210		40		10	180			60° ^{D)}
BB10	15	150 ^{A)}				10	220	B)		
BB15	15	150 ^{A)}				10	220	B)		
BB20	15	150 ^{A)}				10	220	B)		
BB24	25	150 ^{A)}				10	220	3 B)		
BB30	25	150 ^{A)}				30	220	3 B)		
BB34	25	128 ^{A)}				30	220	2 B)		
BB35	25	150 ^{A)}				30	220	3 B)		
BB40		128		30		30	220	2.5 B)		50°
BB80		150	12	40	138	30	220	3 B)		
BB81		150	12	50	138	30	220	3 B)		
BE10	51 / 41 ^{C)}	220				10	250	B)		
BF50	15	60				15	60			
BF51	30	120				15	60			
BK10	50	220				50	250	B)		
BO10	40	220				10	250	5 B)		
BO20	40	220				10	250	5 B)		
BO30	40	220				10	250	4 B)		
BO75		210	40			10	180		10°	60°
DB10	30	150 ^{A)}				10	220	2.2 B)		
DB20	30	150 ^{A)}				10	220	2.2 B)		
PB10	20	150				10	400 ^{B)}	B)		
PB40		100	0	20	100	10	250			
PB41		150	0	20	75	10	250			
PB60		150	12	20	88	10	250		10°	89°
PB61		150	12	20	69	10	250		10°	89°
PB70		100	0	20	100	10	250		10°	89°
PB71		150	0	20	75	10	250		10°	89°
PB80		100	12	40	88	30	250			
PB81		150	12	40	69	30	250			
PE10	26	220				10	400 ^{B)}	5 B)		
PE11	26	220				10	400 ^{B)}	5 B)		
PE60		220	12	26	88	10	250	5 B)	10°	89°
PE61		220	12	26	69	10	250	5 B)	10°	89°
PE70		100	0	26	100	10	250		10°	89°
PE71		150	0	26	75	10	250		10°	89°
PR10	20	220				10	400 ^{B)}	6 B)		
PR11	20	220				10	400 ^{B)}	6 B)		

A: From a system width of 120 cm and wider, the bottom bar may flex slightly. (No warranty claim!)

B: Please note: the max. system dimensions also depend on the fabric selection

C: Up to a height of 200 cm

D: Up to 50° with cord lock; over 50° without a cord lock

General Fitting Information

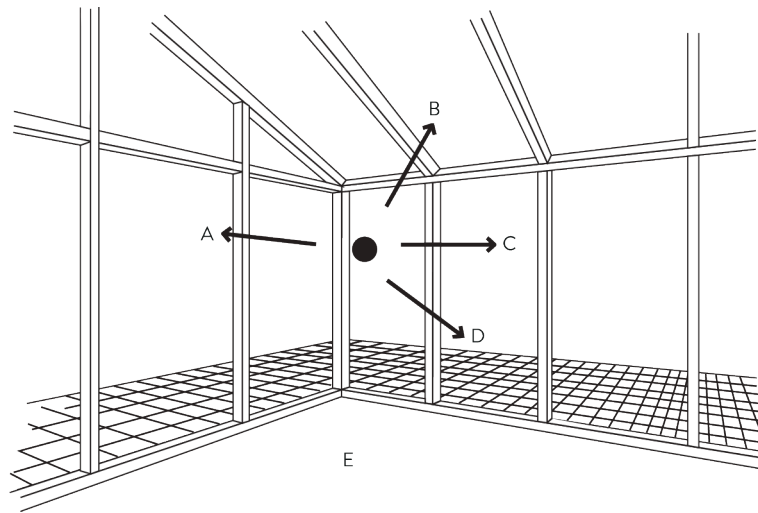

- Please measure the width / height dimensions several times
 - For inside recess fix use the smallest frame measurement.
For outside recess fix measure the size of the actual space
 - Make any necessary deductions
 - Take into account any existing fittings or window furniture when mounting directly onto a frame
- A: Left
B: Top
C: Right
D: Bottom
E: Room inside

Important note for mounting with clamp brackets for plastic windows (option M4):

When using clamp brackets for plastic windows the width can be measured as desired. Fittings, etc. must be taken into account. For all blind types with side-guides, 2 cm must be subtracted from the wing height to obtain the ordering height. With freehanging models, the ordering height is determined individually. However, at the top 1 cm height deduction must be taken into account.

B. MEASUREMENT

Inside Recess Fix

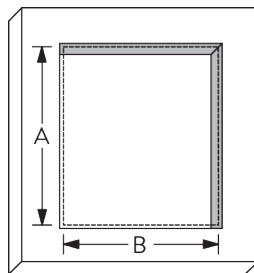

Rectangular shapes

Determine the clear dimensions and make any required deductions (we recommend 0.5 cm in width and height). The measurements given will be used unchanged.

Ordering width B = reveal width minus 0.5 cm
Ordering width A = reveal height minus 0.5 cm

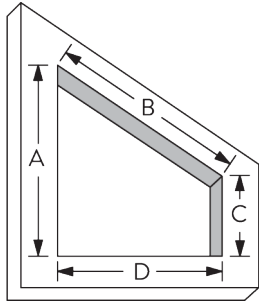

Special shapes

Determine the reveal dimensions (no deductions necessary).
 Deductions will be determined through Silent Gliss.
 Please provide sketch with all measurements!

Ordering widths D / B = clear widths
 Ordering widths A / C = clear heights

Outside Recess Fix

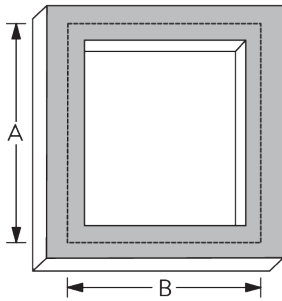

Rectangular shapes

Measure the dimensions and make any allowances, consider any fixtures and fittings.
 The data given will be used unchanged.

Ordering widths B = reveal width plus allowances (left + right)
 Ordering widths A = reveal height plus allowances (top + bottom)

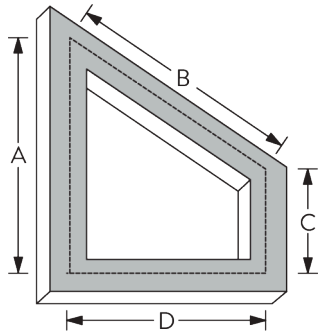

Special shapes

Measure the dimensions considering the overlap each side and any fixtures and fittings. These are the measurements when ordering. Please be aware that the actual width of the blind could be narrower depending on the angle and size of the window. Please provide a drawing with your order.

Ordering widths D / B = determined outside dimensions
 Ordering heights A / C = determined outside dimensions

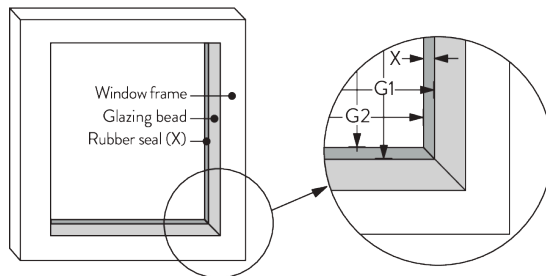

Self-adhesive installation profiles (O7)

Measure the dimensions and make any allowances, consider any fixtures and fittings.
 The data given will be used unchanged.

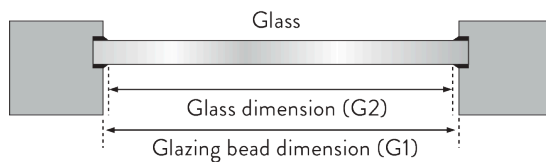

Glazing bead straight

If rubber seal (X) = less than 0.5 cm

Ordering widths / ordering heights = glazing bead dimension (G1) - 0.3 cm

If rubber seal (X) = greater than 0.5 cm

Ordering widths / ordering heights = glazing bead dimension (G2) + 0.7 cm

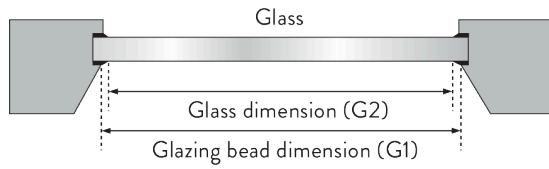

Glazing bead sloped

If rubber seal (X) = less than 0.5 cm

Ordering widths / ordering heights = glazing bead dimension (G1) - 0.1 cm

If rubber seal (X) = greater than 0.5 cm

Ordering widths / ordering heights = glazing bead dimension (G2) + 0.7 cm

**C. INSIDE RECESS
FIX / OUTSIDE
RECESS FIX**

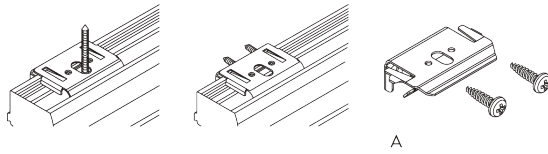

A

Universal bracket

A: Universal bracket incl. screws

D. FITTING OPTIONS

Support bracket (M1-M3)

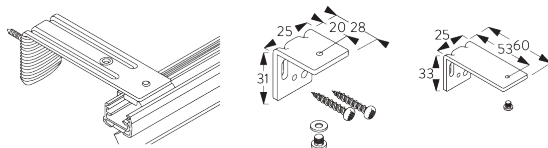

A

B

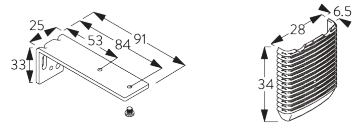

C

D

A: Support bracket 28 mm (M1) incl. screws

B: Support bracket 60 mm (M2) incl. screws

C: Support bracket 91 mm (M3) incl. screws

D: Cover for support bracket

**Fitting with clamp
bracket (M4)**

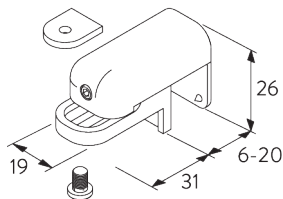

Clamp bracket for plastic windows

**Installation with
glazing bead support
(M5)**

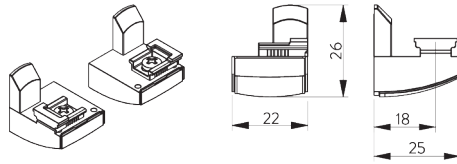

Glass bead support incl. screws for blind type BB24 / BB34 up to a width of max. 128 cm.

**Installation in glazing
bead (M6)**

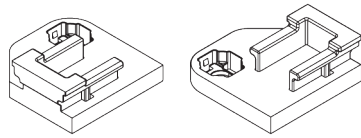

Min. 9 mm straight support surface for blind type BB24 / BB34 up to a width of max. 128 cm.

E. SYSTEM OPTIONS

**Additional finishing
profile (O1)**

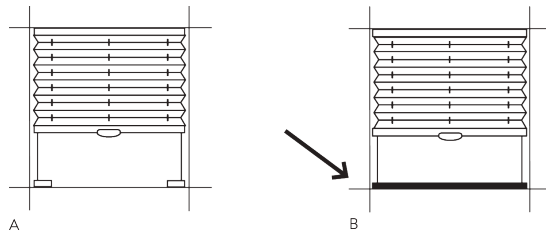

A: Standard
B: with finishing profile

Applicable for all rectangular B and D blind types.

**Additional side-guide
profiles (O2 / O3)**

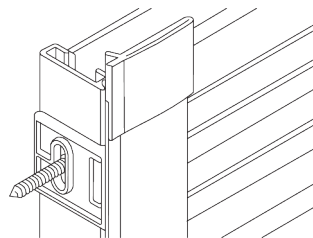

L-Form (O2)

For glazing beads 90° or 96°.
Suitable for all rectangular models (excl. models with cord or chain operation).
P models up to a height of max. 150 cm.
Side guide profiles can only be ordered at the same time as the system and cannot be retrofitted.

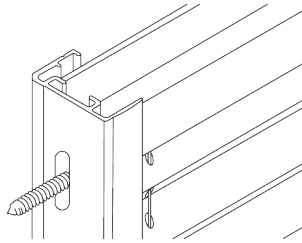

U-Form (O3)

For glazing beads 90°.
 Suitable for all rectangular models (excl. models with chain, crank or electric operation).
 P models up to a height of max. 150 cm.
 Side guide profiles can only be ordered at the same time as the system and cannot be retrofitted.

Mounting profile and accessories (O4)

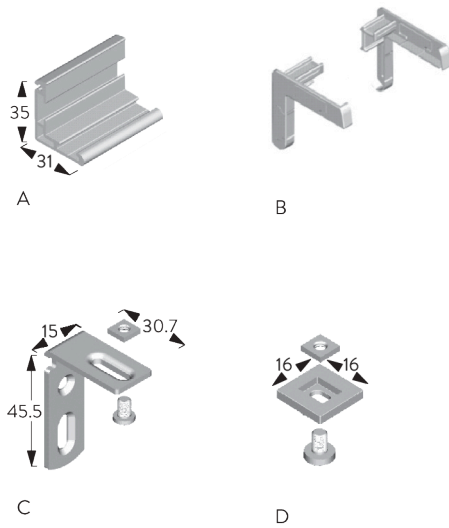

- A: Mounting profile
- B: End cover for mounting profile
- C: Bracket for mounting profile
- D: Connecting screw

Self-adhesive installation profiles (O7)

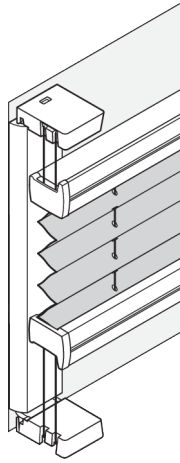

Installation of the system directly on the glass, without any drilling or screwing. The retaining strips are glued to the window pane, then the brackets are attached.
Applicable with blind type BB24 / BB34 up to a width of max. 128 cm.

Control wands / Crank

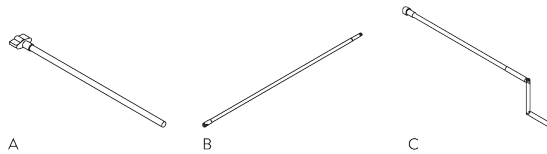

Blind types with plastic operating handle

A: Control wand 301000075, made-to-measure up to max. 200 cm

B: Control wand 201210365, extendable 160-300 cm

Blind types with crank

C: Crank 301000077, made-to-measure up to max. 300 cm

PLEATED BLIND TYPES

A. VERTICAL WINDOWS / RECTANGULAR SHAPES

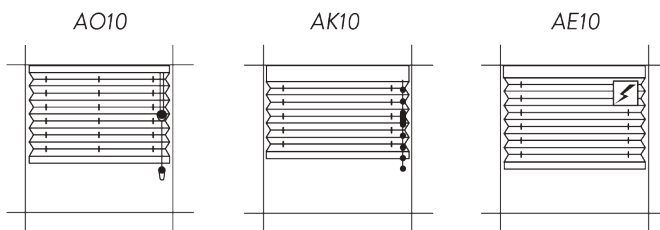

Standard fitting:	Top / Inside recess fix	Top / Inside recess fix	Top / Inside recess fix
Fitting options:	M1 / M2 / M3 / M4	M1 / M2 / M3 / M4	M1 / M2 / M3 / M4
System options:	O3	-	O2
Operation:	Pull cord with cord lock	Chain with safety retainer. Gear in headrail (34 mm)	Electric. Motor (24 V DC) in headrail (34 mm)
Stacking:	Top stack	Top stack	Top stack

- Pleated blinds freehanging
- Attention! Please note the minimum and maximum measurement restrictions in the tables on pages 6 / 7!

B. VERTICAL WINDOWS / SPECIAL SHAPES

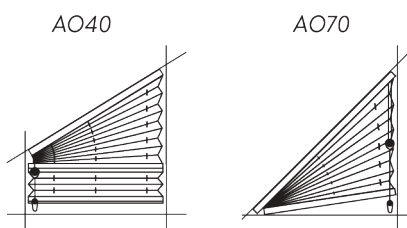

Standard fitting:	Top / Inside recess fix	Top / Inside recess fix
Fitting options:	M1 / M2 / M3	M1 / M2 / M3
System options:	-	-
Operation:	Pull cord with cord lock, only smaller height	Pull cord with cord lock, only greater height
Stacking:	Top stack, raising to the slope	Top stack, raising to the slope

- Pleated blinds freehanging
- Attention! Please note the minimum and maximum measurement restrictions in the tables on pages 6 / 7!

**C. VERTICAL
WINDOWS UP TO
15° INCLINATION /
RECTANGULAR
SHAPES**

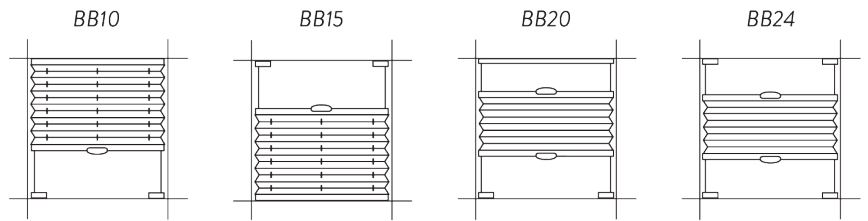

Standard fitting:	Top / Inside recess fix	Top / Inside recess fix	Top / Inside recess fix	Top / Inside recess fix
Fitting options:	M1 / M2 / M3 / M4	M1 / M2 / M3 / M4	M1 / M2 / M3 / M4	M1 / M2 / M3 / M4 / M5 / M6
System options:	O1 / O2 / O3	O2 / O3	O1 / O2 / O3	O2 / O3 / O7
Operation:	Handle	Handle	2 handles	2 handles
Stacking:	Top stack, with bottom side-guide fixing	Bottom stack, with top side-guide fixing	At the top and bottom adjustable blind. With top headrail and bottom side-guide fixing	At the top and bottom adjustable blind. With top and bottom side-guide fixing

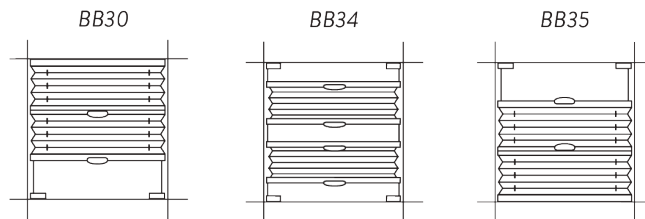

Standard fitting:	Top / Inside recess fix	Top / Inside recess fix	Top / Inside recess fix
Fitting options:	M1 / M2 / M3 / M4	M1 / M2 / M3 / M4 / M5 / M6	M1 / M2 / M3 / M4
System options:	O1 / O2 / O3	O2 / O3 / O7	O2 / O3
Operation:	2 handles	4 handles	2 handles
Stacking:	With 2 different fabrics (day and night decoration), top stack. With bottom side-guide fixing	With 2 different fabrics (day and night decoration). With top and bottom side-guide fixing	With 2 different fabrics (day and night decoration), bottom stack. With top side-guide fixing

- Pleated blinds with side-guides
- Up to 15° inclination
- Incl. tilt and turn windows
- Attention! Please note the minimum and maximum measurement restrictions in the tables on pages 6 / 7!

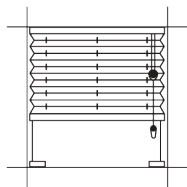
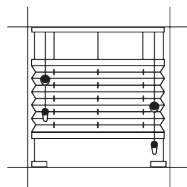
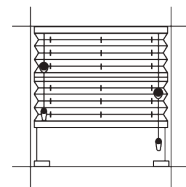
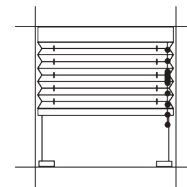
	BO10	BO20	BO30	BK10
				
Standard fitting:	Top / Inside recess fix	Top / Inside recess fix	Top / Inside recess fix	Top / Inside recess fix
Fitting options:	M1/M2/M3/M4	M1/M2/M3/M4	M1/M2/M3/M4	M1/M2/M3/M4
System options:	O1/O3	O1/O3	O1/O3	O1
Operation:	Pull cord with cord lock	Pull cord with 2 cord locks	Pull cord with 2 cord locks	Chain with safety retainer. Gear in headrail (34 mm)
Stacking:	Top stack, with bottom side-guide fixing	At the top and bottom adjustable blind. With top headrail and bottom side-guide fixing	With 2 different fabrics (day and night decoration), top stack. With bottom side-guide fixing	Top stack, with bottom side-guide fixing

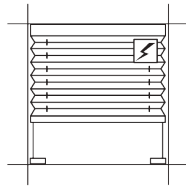
	BE10
	
Standard fitting:	Top / Inside recess fix
Fitting options:	M1/M2/M3/M4
System options:	O1/O2
Operation:	Electric. Motor (24 V DC) in headrail (34 mm)
Stacking:	Top stack, with bottom side-guide fixing

- Pleated blinds with side-guides
- Up to 15° inclination
- Incl. tilt and turn windows
- Attention! Please note the minimum and maximum measurement restrictions in the tables on pages 6 / 7!

**D. VERTICAL
WINDOWS UP TO
15° INCLINATION /
SPECIAL SHAPES**

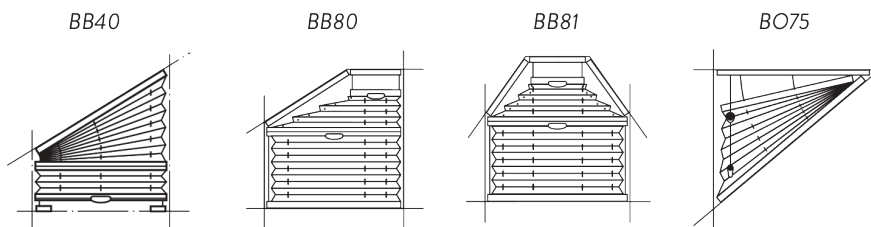

Standard fitting:	Top / Inside recess fix	Top / Inside recess fix	Top / Inside recess fix	Top / Inside recess fix
Fitting options:	M1 / M2 / M3	M1 / M2 / M3	M1 / M2 / M3	M1 / M2 / M3
System options:	O1	-	-	-
Operation:	Handle	2 handles	2 handles	Pull cord with cord lock
Stacking:	Top stack, raising to the smaller height	Bottom stack with side-guide and top headrail on the slope	Bottom stack with side-guide and top headrail on the slopes	Bottom stack with side-guide and top headrail

- Pleated blinds with side-guides
- Up to 15° inclination
- Incl. tilt and turn windows
- Attention! Please note the minimum and maximum measurement restrictions in the tables on pages 6 / 7!

**E. VERTICAL
WINDOWS /
ROUND SPECIAL
SHAPES**

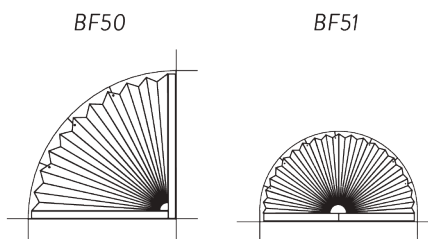

Standard fitting:	Top / Inside recess fix	Top / Inside recess fix
Fitting options:	-	-
System options:	-	-
Operation:	Fixed	Fixed
Stacking:	Fabric with pressed eyelets for fastening with hook bolts	Fabric with pressed eyelets for fastening with hook bolts

- Blind fixed, not movable
- Attention! Please note the minimum and maximum measurement restrictions in the tables on pages 6 / 7!

**F. ROOF AND PIVOT
WINDOWS UP TO
60°
INCLINATION /
RECTANGULAR
SHAPES**

DB10

DB20

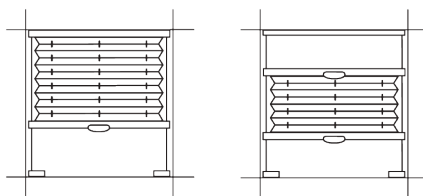

Standard fitting:	Top / Inside recess fix	Top / Inside recess fix
Fitting options:	M1/M2/M3	M1/M2/M3
System options:	O1/O2/O3	O1/O2/O3
Operation:	Handle	2 handles
Stacking:	Top stack, with bottom side-guide fixing	At the top and bottom adjustable blind. With top headrail and bottom side-guide fixing

- Pleated blinds with side-guides
- Up to 60° inclination
- Attention! Please note the minimum and maximum measurement restrictions in the tables on pages 6 / 7!

**G. CEILING
WINDOWS AND
SKYLIGHTS,
INCLINATION
BETWEEN 45° AND
90° /
RECTANGULAR
SHAPES**

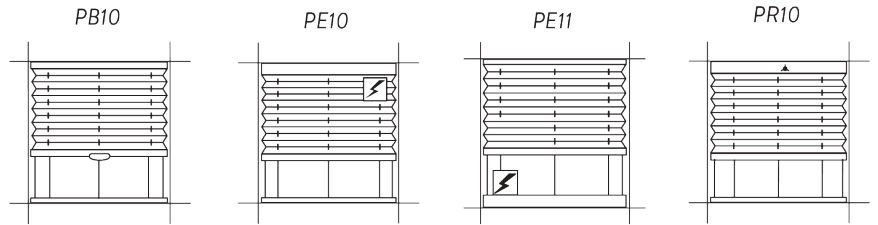

Standard fitting:	Top / Inside recess fix	Top / Inside recess fix	Top / Inside recess fix	Top / Inside recess fix
Fitting options:	M1/M2/M3	M1/M2/M3	M1/M2/M3	M1/M2/M3
System options:	O2/O3	O2	O2	O2
Operation:	Handle	Electric. Motor (24 V DC) in headrail (34 mm)	Electric. Motor (24 V DC) in bottom rail (34 mm)	Crank on headrail (34 mm)
Stacking:	Top stack with bottom rail	Top stack / gear with bottom rail	Top stack / bottom gear	top stack / gear with bottom rail

PR11

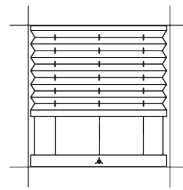

Standard fitting:	Top / Inside recess fix
Fitting options:	M1/M2/M3
System-Optionen:	O2
Operation:	Crank on bottom rail (34 mm)
Stacking:	Top stack / bottom gear

- With permanent steel wire tensioning
- Inclination between 45° and 90° (= horizontal)
- Attention! Please note the minimum and maximum measurement restrictions in the tables on pages 6 / 7!

**H. CEILING
WINDOWS AND
SKYLIGHTS,
INCLINATION
BETWEEN 45°
AND 90° /
SPECIAL SHAPES**

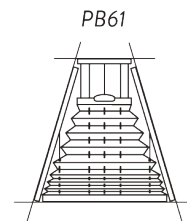
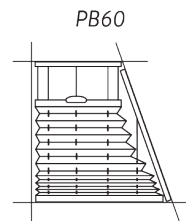
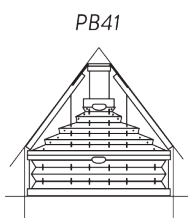
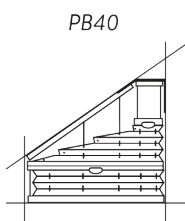

Standard fitting:	Top / Inside recess fix	Top / Inside recess fix	Top / Inside recess fix	Top / Inside recess fix
Fitting options:	-	-	M1/M2/M3	M1/M2/M3
System options:	-	-	-	-
Operation:	2 handles	2 handles	Handle	Handle
Stacking:	Bottom stack with top headrail on the slope	Bottom stack with top headrail on the slopes	Bottom stack with top headrail on the slopes	Bottom stack with top headrail on the slopes

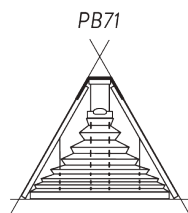
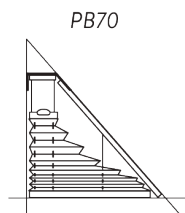

Standard fitting:	Top / Inside recess fix	Top / Inside recess fix
Fitting options:	-	-
System options:	-	-
Operation:	Handle	Handle
Stacking:	Bottom stack with top headrail on the slope	Bottom stack with top headrail on the slopes

- With permanent steel wire tensioning
- Inclination between 45° and 90° (= horizontal)
- Attention! Please note the minimum and maximum measurement restrictions in the tables on pages 6 / 7!

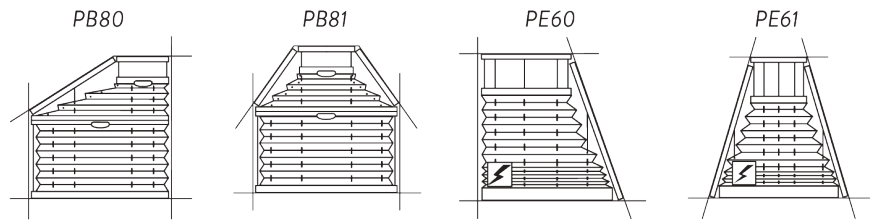

Standard fitting:	Top / Inside recess fix	Top / Inside recess fix	Top / Inside recess fix	Top / Inside recess fix
Fitting options:	M1/M2/M3	M1/M2/M3	M1/M2/M3	M1/M2/M3
System options:	-	-	-	-
Operation:	2 handles	2 handles	Electric. Motor (24 V DC) in bottom rail (34 mm)	Electric. Motor (24 V DC) in bottom rail (34 mm)
Stacking:	Bottom stack with top headrail on the slope	Bottom stack with top headrail on the slopes	Bottom stack / gear with headrail on the slope	Bottom stack / gear with headrail on the slopes

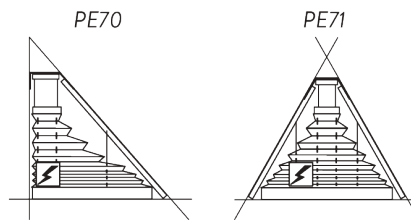

Standard fitting:	Top / Inside recess fix	Top / Inside recess fix
Fitting options:	-	-
System options:	-	-
Operation:	Electric. Motor (24 V DC) in bottom rail (34 mm)	Electric. Motor (24 V DC) in bottom rail (34 mm)
Stacking:	Bottom stack / gear with headrail on the slope	Bottom stack / gear with headrail on the slopes

- With permanent steel wire tensioning
- Inclination between 45° and 90° (= horizontal)
- Attention! Please note the minimum and maximum measurement restrictions in the tables on pages 6 / 7

I. STACK SIZES (MEASUREMENTS IN CM)

Pleated blinds		Blind type			
System height	FC	BB10, BB15, AO10, BO10	BB20, BB24, BO30	BB30, BB35, BO20	BB34
50	1	3,5	4,0	6,0	9,0
	2	4,0	4,5	6,5	9,5
	3	4,5	5,0	7,0	10,0
100	1	4,0	4,5	6,5	10,0
	2	5,0	5,5	7,5	10,5
	3	5,5	6,0	8,5	11,5
150	1	4,5	5,0	7,5	10,5
	2	5,5	6,0	9,0	12,0
	3	7,0	7,5	10,0	13,0
200	1	5,0	5,5	8,5	11,5
	2	6,5	7,0	10,0	13,0
	3	8,0	8,5	12,0	15,0
250	1	5,0	6,0	9,0	12,0
	2	7,0	7,5	11,5	14,5
	3	9,5	10,0	13,5	16,5

FC = Fabric class

DUETTE®		Blind type				
System height	FC	BB10, BB15, AO10, BO10	BB20, BB24, BO30	BB30, BB35, BO20	BB34	
50	2	4,0	5,5	8,0	11,0	
	3	4,5	6,0	9,0	12,0	
	4	5,5	7,0	10,5	13,5	
	5	6,0	7,5	12,0	15,0	
	100	2	5,0	6,5	10,0	13,0
100	3	6,0	7,5	11,5	14,5	
	4	7,5	9,0	14,5	17,5	
	5	9,0	10,5	18,0	21,0	
	150	2	6,0	7,5	11,5	14,5
	3	7,0	8,5	14,0	17,0	
150	4	9,5	11,0	18,5	21,5	
	5	12,0	13,5	23,5	26,5	
	200	2	6,5	8,0	13,0	16,0
	3	8,5	10,0	16,5	19,5	
	4	11,5	13,0	22,5	25,5	
200	5	-	-	-	-	
	250	2	7,5	9,0	14,5	17,5
	3	9,5	11,0	19,0	22,0	
	4	13,0	14,5	26,0	29,0	
	5	-	-	-	-	

Pleated blinds		Blind type	
System height	FC	AE10, AK10	BE10, BK10
50	1	5,5	5,5
	2	6,0	6,0
	3	6,5	6,5
100	1	6,0	6,0
	2	7,0	7,0
	3	7,5	7,5
150	1	6,5	6,5
	2	7,5	7,5
	3	9,0	9,0
200	1	7,0	7,0
	2	8,5	8,5
	3	10,0	10,0
250	1	7,0	7,0
	2	9,0	9,0
	3	11,5	11,5

FC = Fabric class

DUETTE®		Blind type	
System height	FC	AE10, AK10	BE10, BK10
50	2	6,0	6,0
	3	6,5	6,5
	4	7,0	7,0
	5	8,0	8,0
100	2	7,0	7,0
	3	8,0	8,0
	4	9,0	9,5
	5	11,0	11,0
150	2	7,5	7,5
	3	9,0	9,0
	4	11,0	11,5
	5	13,5	14,0
200	2	8,5	8,5
	3	10,0	10,5
	4	13,0	13,0
	5	-	-
250	2	9,0	9,5
	3	11,5	11,5
	4	15,0	15,0
	5	-	-

Pleated blinds		Blind type	
System height	FC	AO40, BB40, BB80, BB81	AO70, BO75
50	1	5,0	3,5
	2	5,5	4,0
	3	6,0	4,5
100	1	5,5	4,0
	2	6,0	4,5
	3	7,0	5,5
150	1	6,0	4,5
	2	7,0	5,5
	3	8,5	7,0
200	1	6,5	5,0
	2	8,0	6,5
	3	9,5	8,0
250	1	7,0	5,5
	2	8,5	7,0
	3	11,0	9,5

FC = Fabric class

DUETTE®		Blind type	
System height	FC	AO40, BB40, BB80, BB81	AO70, BO75
50	2	5,5	4,0
	3	6,0	4,5
	4	6,5	5,0
	5	7,5	6,0
100	2	6,5	5,0
	3	7,0	5,5
	4	8,5	7,0
	5	10,5	9,0
150	2	7,0	5,5
	3	8,5	7,0
	4	11,0	9,0
	5	13,0	11,5
200	2	8,0	6,5
	3	10,0	8,0
	4	12,5	11,0
	5	-	-
250	2	9,0	7,0
	3	11,0	9,5
	4	14,5	13,0
	5	-	-

Pleated blinds		Blind type	
System height	FC	DB10	DB20
50	1	4,0	4,5
	2	4,5	5,0
	3	5,0	5,5
100	1	4,5	5,0
	2	5,0	5,5
	3	6,0	6,5
150	1	5,0	5,5
	2	6,0	6,5
	3	7,5	8,0
200	1	5,5	6,0
	2	7,0	7,5
	3	8,5	9,0

FC = Fabric class

DUETTE®		Blind type	
System height	FC	DB10	DB20
50	2	4,5	5,0
	3	5,0	5,5
	4	5,5	6,0
	5	6,5	7,0
100	2	5,5	6,0
	3	6,0	6,5
	4	7,5	8,0
	5	9,5	10,0
150	2	6,0	6,5
	3	7,5	8,0
	4	9,5	10,0
	5	12,0	12,5
200	2	7,0	7,5
	3	8,5	9,0
	4	11,5	12,0
	5	-	-

Pleated blinds		Blind type	
System height	FC	PB10, PE11, PR11	PE10, PR10
50	1	4,0	6,0
	2	4,5	6,5
	3	5,0	7,0
100	1	4,5	6,5
	2	5,0	7,0
	3	6,0	8,0
150	1	5,0	7,0
	2	6,0	8,0
	3	7,5	9,5
200	1	5,5	7,5
	2	7,0	9,0
	3	9,0	10,5
250	1	6,0	8,0
	2	8,0	10,0
	3	10,0	12,0
300	1	6,0	8,0
	2	8,5	10,5
	3	11,0	13,0
350	1	6,5	8,5
	2	9,0	11,0
	3	12,0	14,0

FC = Fabric class

DUETTE®		Blind type	
System height	FC	PB10, PE11, PR11	PE10, PR10
50	2	4,5	6,5
	3	5,0	7,0
	4	5,5	7,5
	5	6,5	8,5
	2	5,5	7,5
100	3	6,0	8,0
	4	7,5	9,5
	5	9,5	11,5
150	2	6,0	8,0
	3	7,5	9,5
	4	10,0	11,5
	5	12,0	14,0
	2	7,0	9,0
200	3	8,5	10,5
	4	11,5	13,5
	5	-	-
	2	8,0	10,0
	3	10,0	12,0
250	4	13,5	15,5
	5	-	-
	2	8,5	10,5
	3	11,0	13,0
	4	15,0	17,0
300	5	-	-
	2	9,0	11,0
	3	12,0	14,0
	4	17,0	19,0
	5	-	-

Pleated blinds		Blind type		
System height	FC	PB40, PB41, PB80, PB81	PB60, PB61, PB70, PB71	PE60, PE61, PE70, PE71
50	1	6,0	4,0	6,0
	2	6,5	4,5	6,5
	3	7,0	5,0	7,0
100	1	6,5	4,5	6,5
	2	7,5	5,5	7,5
	3	8,0	6,0	8,0
150	1	7,0	5,0	7,0
	2	8,0	6,0	8,0
	3	9,5	7,5	9,5
200	1	7,5	5,5	7,5
	2	9,0	7,0	9,0
	3	10,5	8,5	10,5
250	1	8,0	6,0	8,0
	2	9,5	7,5	9,5
	3	12,0	10,0	12,0







FC = Fabric class

DUETTE®		Blind type		
System height	FC	PB40, PB41, PB80, PB81	PB60, PB61, PB70, PB71	PE60, PE61, PE70, PE71
50	2	6,5	4,5	6,5
	3	7,0	5,0	7,0
	4	7,5	5,5	7,5
	5	8,5	6,5	8,5
	2	7,0	5,0	7,0
100	3	8,0	6,0	8,0
	4	9,5	7,5	9,5
	5	11,5	9,5	11,5
150	2	8,0	6,0	8,0
	3	9,5	7,5	9,5
	4	11,5	9,5	11,5
	5	14,0	12,0	14,0
	2	9,0	7,0	9,0
200	3	10,5	8,5	10,5
	4	13,5	11,5	13,5
	5	-	-	-
	2	9,5	7,5	9,5
	3	12,0	10,0	12,0
250	4	-	-	-
	5	-	-	-

ELECTRIC OPTIONS

A. OPERATING METHODS

Switch with power supply	•									
Control unit without power supply		•								
Power supply			•	•						
Radio control 1-channel								•		
Radio control 4-channel									•	
Radio receiver										•

Blind type	Option	Control by wire	Radio control	Single control	Group control							
						UP 308001130	UP 308001093	* 305000514	308001137	308001089	308001090	* 308001132
AE BE PE	E11	•		•		•						
	E12	•			•		• (1)		• (2)			
	E13			•	•			•	•			•
	E14		•	•	•				• (2)		•	• (3)

- * Installation of the radio receiver 308001132 in the top rail increases the minimum width of PE models by 10 cm! Additional installation of the power supply unit 305000514 in the top rail increases this dimension by a further 25 cm!

- (1) a maximum of 3 motors
- (2) a maximum of 5 motors
- (3) per motor

- In order to ensure that the systems function properly, only electrical components recommended by Silent Gliss may be used!

- The use of components not recommended by Silent Gliss will invalidate the warranty!

PARTS

A. STANDARD PARTS

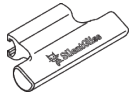

SG 8325

Handle

B. OPTIONAL PARTS



SG 8501

Logoplate



SG 10742

Child safety cord cleat

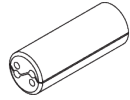

SG 10745

Child safety break away cord connector

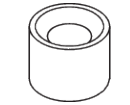

SG 10749

Eyelet

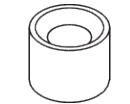

SG 10898

Child safety cord bush

