

# SG 1080

---

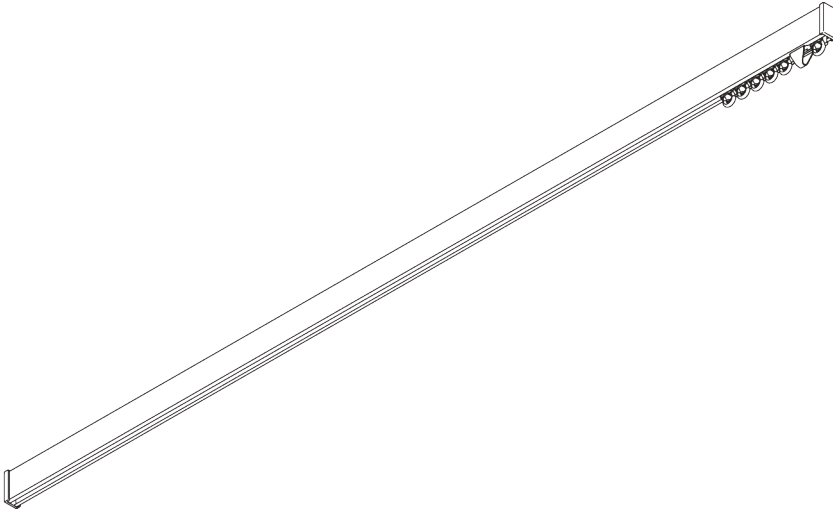

## PRODUCT INFORMATION

- **Operation:** hand
- **Range:** S
- **Fitting:** ceiling, wall, suspended
- **Colours:** white RAL 9016, black RAL 9005 or anodised aluminum, special colours possible
- **Fabrics:** refer to Silent Gliss fabric collection

### **Features:**

- Bendable

# SYSTEM SPECIFICATIONS

## A. PROFILE

Profile and bending information

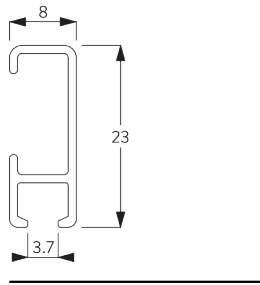

**SG 1080p**

Profile

Radius:  
✓ 6 cm, 10 cm, >30 cm

## B. HOW TO MEASURE

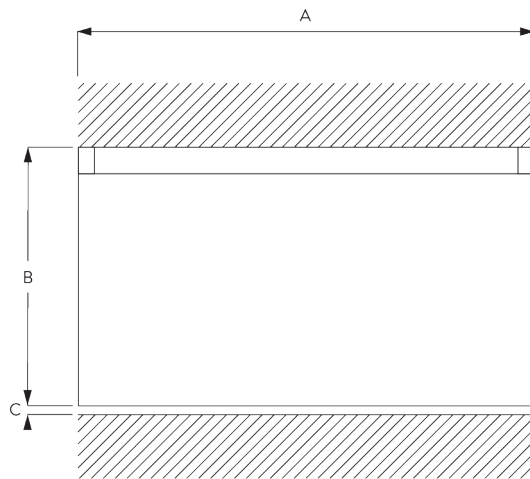

A: System width  
B: System height  
C: Distance between floor and fabric

## C. SPECIFICATION

TEXT

**Silent Gliss SG 1080 Hand Drawn Curtain Track System.** Comprises aluminium profile SG 1080 supplied made to measure in silver anodised or powder coated white / matt white / anodic grey / antique bronze / charcoal / black with gliders SG 3533 at 16/m and 2 end covers SG 3667 / end stops SG 3016 per length. Top fixed with brackets SG 3603 at max. 600mm centres / wall fix with universal brackets SG 3630 / SG 3655 / SG 3660 / SG Smart Fix at max. 600mm centres.

# FITTING

## A. FITTING INFORMATION

Fixing points

For detailed fitting information, visit the [Silent Gliss website](#).

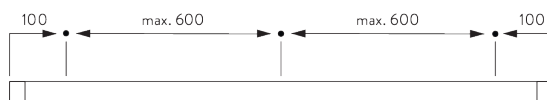

## B. CEILING FITTING

### Bracket SG 3603

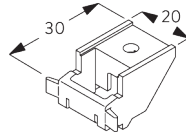
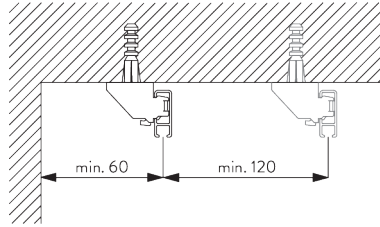

**SG 3603**  
Bracket

## C. WALL FITTING

### Smart Fix

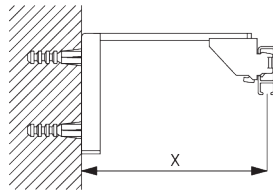

**Smart Fix SG 11200 - SG 11205 and bracket SG 3603:**  
Screw SG 10492 (M4x8) needed.

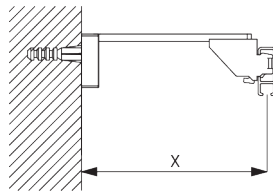

**Square Smart Fix SG 11210 - SG 11215 and bracket SG 3603:**  
Screw SG 10492 (M4x8) needed.

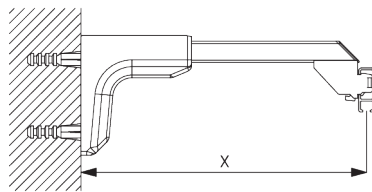

**Universal Smart Fix SG 11154 - SG 11156 and bracket SG 3603:**  
Screw SG 10277 (M4x12) needed.

Smart Fix	X mm
SG 11200 / SG 11210	70
SG 11201 / SG 11211	90
SG 11202 / SG 11212	110
SG 11203 / SG 11213	130
SG 11204 / SG 11214	160
SG 11205 / SG 11215	210
SG 11154	120-148
SG 11155	150-178
SG 11156	200-228

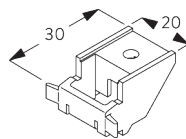

**SG 3603**  
Bracket



**SG 10492**  
Pan head screw M4x8



**SG 10277**  
Pan head screw M4x12

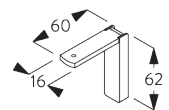

**SG 11200**  
Smart Fix 60 mm

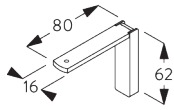

**SG 11201**  
Smart Fix 80 mm

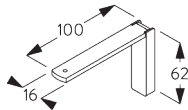

**SG 11202**  
Smart Fix 100 mm

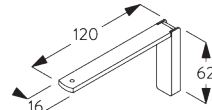

**SG 11203**  
Smart Fix 120 mm

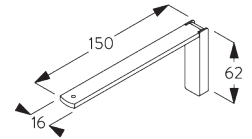

**SG 11204**  
Smart Fix 150 mm

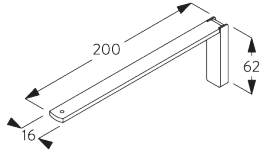

**SG 11205**  
Smart Fix 200 mm

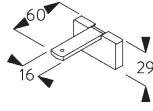

**SG 11210**  
Square Smart Fix 60 mm

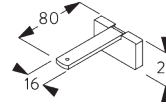

**SG 11211**  
Square Smart Fix 80 mm

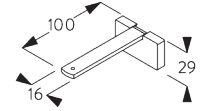

**SG 11212**  
Square Smart Fix 100 mm

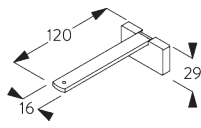

**SG 11213**  
Square Smart Fix 120 mm

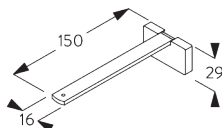

**SG 11214**  
Square Smart Fix 150 mm

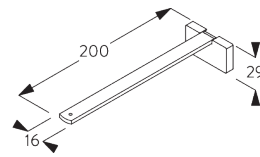

**SG 11215**  
Square Smart Fix 200 mm

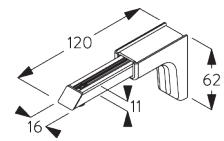

**SG 11154**  
Universal Smart Fix 120 mm

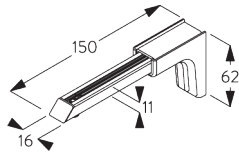

**SG 11155**  
Universal Smart Fix 150 mm

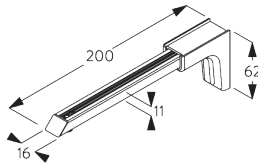

**SG 11156**  
Universal Smart Fix 200 mm

**Universal brackets  
SG 3630, SG 3655,  
SG 3660**

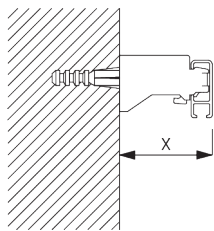

Bracket	X mm
SG 3630	33
SG 3655	48
SG 3660	63

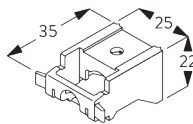

**SG 3630**  
Bracket 35 mm

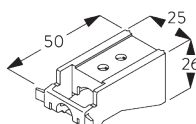

**SG 3655**  
Bracket 50 mm

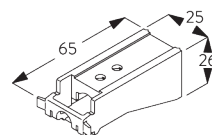

**SG 3660**  
Bracket 65 mm

**D. SUSPENDED  
FITTING**

**Hanger SG 3639 /  
wall support SG 3602**

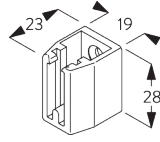
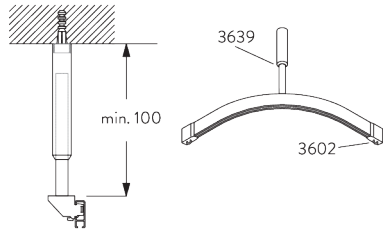

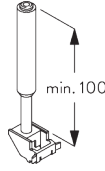

**SG 3602**  
*Wall support*









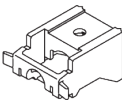
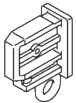



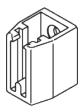

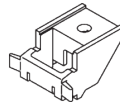

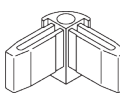

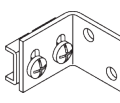

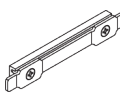

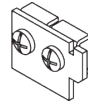

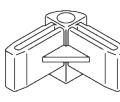

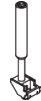
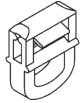
**SG 3639**  
*Hanger*

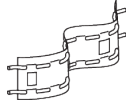
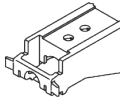
# PARTS

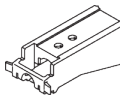
## A. STANDARD PARTS

	<b>SG 1080p</b> Profile
	<b>SG 3533</b> Glider
	<b>SG 3630</b> Bracket 35 mm
	<b>SG 3667</b> End cover

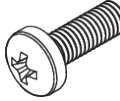
## B. OPTIONAL PARTS

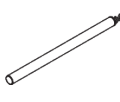
	<b>SG 3016</b> End stop		<b>SG 3602</b> Wall support
	<b>SG 3020</b> Hook		<b>SG 3603</b> Bracket
	<b>SG 3032</b> Spring stop		<b>SG 3604</b> Corner connector
	<b>SG 3070</b> End stop		<b>SG 3618</b> Wall bracket
	<b>SG 3071</b> End stop		<b>SG 3620</b> Connection bridge
	<b>SG 3151</b> Spacer		<b>SG 3626</b> Return holder
	<b>SG 3511</b> Glider		<b>SG 3638</b> Corner connector
	<b>SG 3534</b> Glider 3533 on strip		<b>SG 3639</b> Hanger
	<b>SG 3548</b> Glider		<b>SG 3648</b> Eyelet
	<b>SG 3562</b> Heading tape		<b>SG 3655</b> Bracket 50 mm
	<b>SG 3570</b> Glider		<b>SG 3660</b> Bracket 65 mm
	<b>SG 3571</b> Hook		<b>SG 6146</b> Hook
	<b>SG 3582</b> Hook		<b>SG 10277</b> Pan head screw M4x12
	<b>SG 3599</b> Hook		<b>SG 10430</b> Draw rod 50 cm

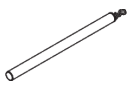

**SG 10431**

*Draw rod 75 cm*



**SG 10432**

*Draw rod 100 cm*

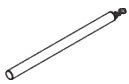

**SG 10433**

*Draw rod 125 cm*

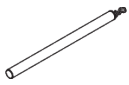

**SG 10434**

*Draw rod 150 cm*

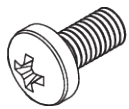

**SG 10492**

*Pan head screw M4x8*

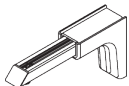

**SG 11154**

*Universal Smart Fix 120 mm*

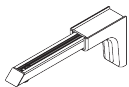

**SG 11155**

*Universal Smart Fix 150 mm*

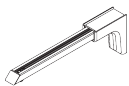

**SG 11156**

*Universal Smart Fix 200 mm*

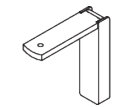

**SG 11200**

*Smart Fix 60 mm*

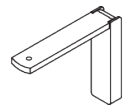

**SG 11201**

*Smart Fix 80 mm*

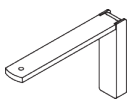

**SG 11202**

*Smart Fix 100 mm*

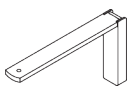

**SG 11203**

*Smart Fix 120 mm*

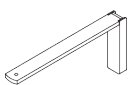

**SG 11204**

*Smart Fix 150 mm*

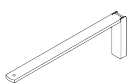

**SG 11205**

*Smart Fix 200 mm*

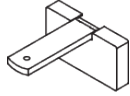

**SG 11210**

*Square Smart Fix 60 mm*

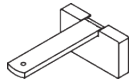

**SG 11211**

*Square Smart Fix 80 mm*

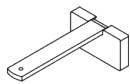

**SG 11212**

*Square Smart Fix 100 mm*

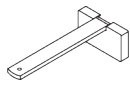

**SG 11213**

*Square Smart Fix 120 mm*

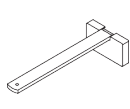

**SG 11214**

*Square Smart Fix 150 mm*

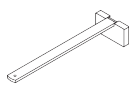

**SG 11215**

*Square Smart Fix 200 mm*

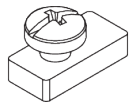

**SG 11335**

*End stop*

